

Floating Joint

Standard/Light Weight Type 20, 30, 40, 63

New

RoHS

Light weight

With the aluminum case

30% Weight reduction

*Compared to the existing model JA40



Product suitable for air cylinders

- Light weight mitigates lateral loads to air cylinders.
- Maximum tensile force equivalent to 1 MPa

Floating joint compensates for any misalignment between the work piece and the air cylinder.

Interchangeable mounting with the existing JA series

Rotating angle $\pm 5^\circ$

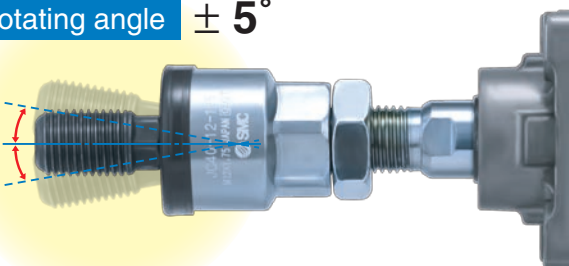

Allowable eccentricity ± 0.5 to 1 mm

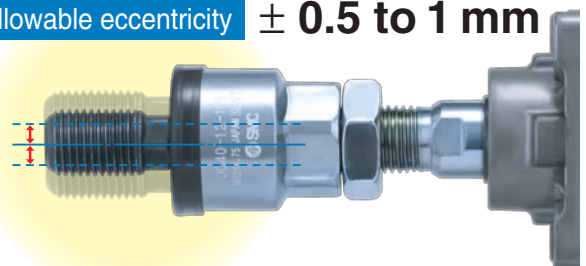





Series JC

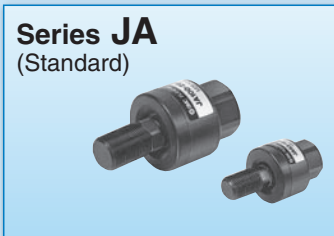

CAT.ES20-233A

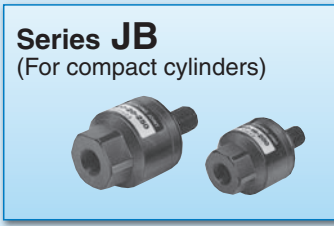
Series Variations

Series	Cylinder supply pressure	Applicable cylinder bore size (mm)	Mounting	Page
 <p>New Series JC (Light weight type)</p>	<p>Pneumatic cylinder</p> <p>1 MPa or less</p>	<p>20, 25, 32, 40, 50, 63</p>	<p>Basic style</p>	<p>Catalog P.1</p>
 <p>Series JA (Standard)</p>	<p>Pneumatic cylinder</p> <p>0.7 MPa or less</p>	<p>6, 10, 15</p>	<p>Basic style · Flange style · Foot style</p>	<p>Best Pneumatics 2 Best Pneumatics P.908</p>
	<p>Hydraulic cylinder</p> <p>3.5 MPa or less</p>	<p>20, 25, 30, 40, 50, 63 80, 100, 125, 140, 160</p>		
 <p>Series JAH (Heavy load)</p>	<p>Hydraulic cylinder</p> <p>7 MPa or less</p>	<p>40, 50, 63, 80, 100</p>	<p>Basic style · Flange style · Foot style</p>	<p>Best Pneumatics 2 Best Pneumatics P.913</p>
 <p>Series JB (For compact cylinders)</p>	<p>Pneumatic cylinder</p> <p>1 MPa or less</p>	<p>12, 16, 20, 25, 32 40, 50, 63, 80, 100</p>	<p>Basic style (Female thread)</p>	<p>Best Pneumatics 2 Best Pneumatics P.916</p>
 <p>Series JS (Stainless steel type)</p>	<p>Pneumatic cylinder</p> <p>1 MPa or less</p>	<p>10, 16, 20, 25, 32 40, 50, 63, 80, 100</p>	<p>Basic style</p>	<p>Best Pneumatics 2 Best Pneumatics P.918</p>
	<p>Hydraulic cylinder</p> <p>3.5 MPa or less</p>	<p>20, 25, 32, 40, 50, 63</p>		



Floating Joint

Standard/Light Weight Type

Series JC



Series JC

Model/Specifications

Model	Applicable cylinder bore size (mm)	Applicable cylinder nominal thread size	Maximum operating tensile and compressive force (N)		Allowable eccentricity (Umm)	Rotating angle
			Basic style			
Standard/Thread nominal size						
JC20-8-125	20	M8 x 1.25	300		0.5	± 5°
JC30-10-125	25/32	M10 x 1.25	800		0.5	
JC40-14-150	40	M14 x 1.5	1250		0.75	
JC63-18-150	50/63	M18 x 1.5	3100		1	
Semi-standard/Thread nominal size						
JC20-8-100	20	M8 x 1	300		0.5	± 5°
JC25-10-150	25	M10 x 1.5	800		0.5	
JC32-10-100	32	M10 x 1	800		0.5	
JC40-12-125	32/40	M12 x 1.25	1250		0.75	
JC40-12-150	40	M12 x 1.5	1250		0.75	
JC40-12-175	32/40	M12 x 1.75	1250		0.75	
JC50-16-150	50	M16 x 1.5	3100		1	
JC63-16-200	50/63	M16 x 2	3100		1	

How to Order

JC 40 - 14-150

Applicable cylinder bore size

Model	Symbol	Applicable cylinder bore size (mm)
Standard type	20	20
	30	25/32
	40	40
	63	50/63

Thread nominal size (Standard)

Thread nominal size	Applicable cylinder nominal thread size
8-125	M8 x 1.25
10-125	M10 x 1.25
14-150	M14 x 1.5
18-150	M18 x 1.5

Specifications

Operating pressure	Pneumatic cylinder: 1 MPa or less
Mounting	Basic style
Operating temperature	-10 to 70°C

Operating range

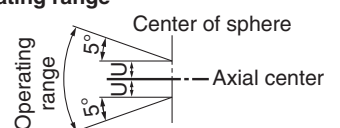

Series JC

Construction

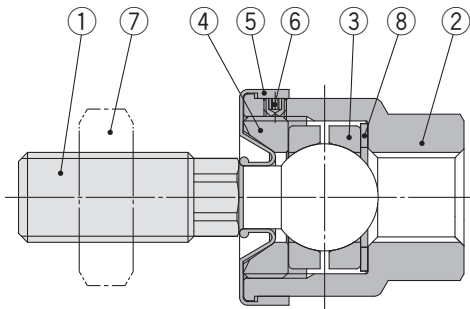

No.	Description	Material	Note
1	Stud	Steel	Manganese phosphate
2	Case	Aluminum	Chromated
3	Ring	Steel	
4	Cap	Steel	Black zinc chromated
5	Dust cover	Synthetic rubber	
6	Set screw	Steel	Zinc chromated
7	Rod end nut	Steel	Zinc chromated
8	Washer	Steel	

Dimensions

JC20 to 63

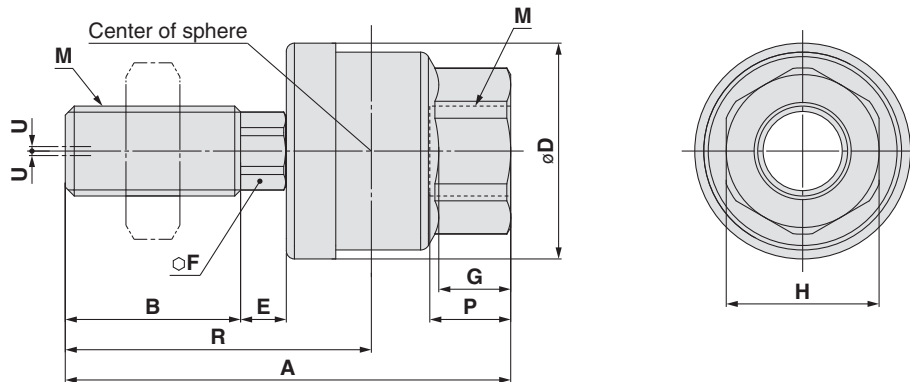

Standard type Pneumatic: to 1 MPa

Applicable cylinder bore size	Model	M		A	B	D	E	F	G	H	Center of sphere R	Maximum thread depth P	Allowable eccentricity U	Maximum operating tensile and compressive force N	Weight kg
		Nominal size	Pitch												
20	JC20-8-125	8	1.25	44	17.5	21	4.5	7	7	13	30.5	8	0.5	300	0.03
25, 32	JC30-10-125	10	1.25	49.5	19.5	24	5	8	8	17	34	9	0.5	800	0.05
40	JC40-14-150	14	1.5	60	20	31	6	11	11	22	38	13	0.75	1250	0.12
50, 63	JC63-18-150	18	1.5	74.5	25	41	7.5	14	13.5	27	47.5	15	1	3100	0.23

Semi-standard type Pneumatic: to 1 MPa

Applicable cylinder bore size	Model	M		A	B	D	E	F	G	H	Center of sphere R	Maximum thread depth P	Allowable eccentricity U	Maximum operating tensile and compressive force N	Weight kg
		Nominal size	Pitch												
20	JC20-8-100	8	1	44	17.5	21	4.5	7	7	13	30.5	8	0.5	300	0.03
25	JC25-10-150	10	1.5	49.5	19.5	24	5	8	8	17	34	9	0.5	800	0.05
32	JC32-10-100	10	1	49.5	19.5	24	5	8	8	17	34	9	0.5	800	0.05
32, 40	JC40-12-125	12	1.25	60	20	31	6	11	11	22	38	13	0.75	1250	0.11
40	JC40-12-150	12	1.5	60	20	31	6	11	11	22	38	13	0.75	1250	0.11
32, 40	JC40-12-175	12	1.75	60	20	31	6	11	11	22	38	13	0.75	1250	0.11
50	JC50-16-150	16	1.5	71.5	22	41	7.5	14	13.5	27	44.5	15	1	3100	0.22
50, 63	JC63-16-200	16	2	71.5	22	41	7.5	14	13.5	27	44.5	15	1	3100	0.22

Dimensions of Accessories

Rod end nut

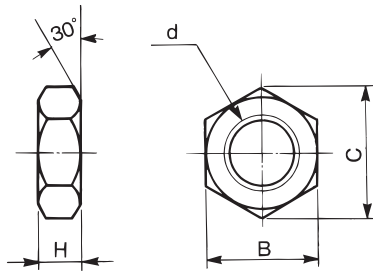

Model	Order number	d: Thread nominal size	H	B	C
JC20-8-100	DA00207	M8 x 1	5	13	15
JC20-8-125	DA00169	M8 x 1.25	5	13	15
JC32-10-100	DA00141	M10 x 1	6	17	19.6
JC30-10-125	DA00142	M10 x 1.25	6	17	19.6
JC25-10-150	DA00140	M10 x 1.5	6	17	19.6
JC40-12-125	DA00145	M12 x 1.25	7	19	21.9
JC40-12-150	DA00146	M12 x 1.5	7	19	21.9
JC40-12-175	DA00143	M12 x 1.75	7	19	21.9
JC40-14-150	DA00148	M14 x 1.5	8	22	25.4
JC50-16-150	DA00151	M16 x 1.5	10	24	27.7
JC63-16-200	DA00150	M16 x 2	10	24	27.7
JC63-18-150	DA00153	M18 x 1.5	11	27	31.2

Spare parts

- **Rod end nut**

The basic style has one rod end nut attached, it is possible to order additional pieces by the above order numbers.

- **Dust cover**

When the dust cover is damaged and deteriorated, order with the part number as shown below.

Part no. for dust cover	Applicable model
P215215	JC20
P215225	JC25, JC30, JC32
P215235	JC40
P215245	JC50, JC63



Series JC

Specific Product Precautions

Be sure to read before handling. Refer to back cover for Safety Instructions, “Handling Precautions for SMC Products” (M-E03-3) for Actuator Precautions.

Mounting

Warning

- 1. To screw the male threads of the rod into the female threads of the socket or the case, make sure that it does not bottom out.**

If the floating joint is used with its rod bottomed out, the stud will not be able to float, causing damage.

For the screw-in depth of the female threads, refer to the dimensions (page 2). As a rule, after the rod bottoms out, back off 1 to 2 turns.

- 2. The dust cover may stick to the stud. Move the dust cover at the base of the stud with fingers, or twist the stud right and left gently to free them.**

And when screwing stud or socket, or case in the driven object, make sure to screw them in the state that dust cover has been removed from the case. If screwing without removing dust cover, dust cover might be broken.

- 3. To use a floating joint to connect the cylinder rod to a driven body, secure it in place by applying a torque that is appropriate for the thread size. Also, if there is a risk of loosening during operation, take measures to prevent loosening, such as using a locking pin or thread adhesive.**

In the event that the connected portion becomes loose, the driven body might lose control or fall off, leading to equipment damage or injury to personnel.

- 4. Do not use for rotational applications, because it is not a fitting designed for rotational axis.**

- 5. When a driven object is stopped, be sure to prevent the impact force of the object being transferred to the product by using the cushion mechanism of a cylinder or other cushioning devices such as a shock absorber. Otherwise, the impact force may exceed the maximum tensile and compressive force of the product.**

Maintenance

Warning

- 1. Do not reuse if disassembled.**

High strength adhesive is applied to the portion of the connection that is threaded to prevent it from loosening, and it must not be disassembled. If it is forcefully disassembled, it could lead to damage.

Safety Instructions

These safety instructions are intended to prevent hazardous situations and/or equipment damage. These instructions indicate the level of potential hazard with the labels of “**Caution**,” “**Warning**” or “**Danger**.” They are all important notes for safety and must be followed in addition to International Standards (ISO/IEC)*1, and other safety regulations.

 **Caution:** **Caution** indicates a hazard with a low level of risk which, if not avoided, could result in minor or moderate injury.

 **Warning:** **Warning** indicates a hazard with a medium level of risk which, if not avoided, could result in death or serious injury.

 **Danger :** **Danger** indicates a hazard with a high level of risk which, if not avoided, will result in death or serious injury.

- *1) ISO 4414: Pneumatic fluid power – General rules relating to systems.
ISO 4413: Hydraulic fluid power – General rules relating to systems.
IEC 60204-1: Safety of machinery – Electrical equipment of machines.
(Part 1: General requirements)
ISO 10218-1: Manipulating industrial robots – Safety.
etc.

Warning

1. The compatibility of the product is the responsibility of the person who designs the equipment or decides its specifications.

Since the product specified here is used under various operating conditions, its compatibility with specific equipment must be decided by the person who designs the equipment or decides its specifications based on necessary analysis and test results. The expected performance and safety assurance of the equipment will be the responsibility of the person who has determined its compatibility with the product. This person should also continuously review all specifications of the product referring to its latest catalog information, with a view to giving due consideration to any possibility of equipment failure when configuring the equipment.

2. Only personnel with appropriate training should operate machinery and equipment.

The product specified here may become unsafe if handled incorrectly. The assembly, operation and maintenance of machines or equipment including our products must be performed by an operator who is appropriately trained and experienced.

3. Do not service or attempt to remove product and machinery/equipment until safety is confirmed.

1. The inspection and maintenance of machinery/equipment should only be performed after measures to prevent falling or runaway of the driven objects have been confirmed.
2. When the product is to be removed, confirm that the safety measures as mentioned above are implemented and the power from any appropriate source is cut, and read and understand the specific product precautions of all relevant products carefully.
3. Before machinery/equipment is restarted, take measures to prevent unexpected operation and malfunction.

4. Contact SMC beforehand and take special consideration of safety measures if the product is to be used in any of the following conditions.

1. Conditions and environments outside of the given specifications, or use outdoors or in a place exposed to direct sunlight.
2. Installation on equipment in conjunction with atomic energy, railways, air navigation, space, shipping, vehicles, military, medical treatment, combustion and recreation, or equipment in contact with food and beverages, emergency stop circuits, clutch and brake circuits in press applications, safety equipment or other applications unsuitable for the standard specifications described in the product catalog.
3. An application which could have negative effects on people, property, or animals requiring special safety analysis.
4. Use in an interlock circuit, which requires the provision of double interlock for possible failure by using a mechanical protective function, and periodical checks to confirm proper operation.

Caution

1. The product is provided for use in manufacturing industries.

The product herein described is basically provided for peaceful use in manufacturing industries.
If considering using the product in other industries, consult SMC beforehand and exchange specifications or a contract if necessary.
If anything is unclear, contact your nearest sales branch.

Limited warranty and Disclaimer/ Compliance Requirements

The product used is subject to the following “Limited warranty and Disclaimer” and “Compliance Requirements”.

Read and accept them before using the product.

Limited warranty and Disclaimer

1. The warranty period of the product is 1 year in service or 1.5 years after the product is delivered, whichever is first.*2)
Also, the product may have specified durability, running distance or replacement parts. Please consult your nearest sales branch.
2. For any failure or damage reported within the warranty period which is clearly our responsibility, a replacement product or necessary parts will be provided.
This limited warranty applies only to our product independently, and not to any other damage incurred due to the failure of the product.
3. Prior to using SMC products, please read and understand the warranty terms and disclaimers noted in the specified catalog for the particular products.

***2) Vacuum pads are excluded from this 1 year warranty.**

A vacuum pad is a consumable part, so it is warranted for a year after it is delivered.
Also, even within the warranty period, the wear of a product due to the use of the vacuum pad or failure due to the deterioration of rubber material are not covered by the limited warranty.

Compliance Requirements

1. The use of SMC products with production equipment for the manufacture of weapons of mass destruction (WMD) or any other weapon is strictly prohibited.
2. The exports of SMC products or technology from one country to another are governed by the relevant security laws and regulations of the countries involved in the transaction. Prior to the shipment of a SMC product to another country, assure that all local rules governing that export are known and followed.

 **Safety Instructions** Be sure to read “Handling Precautions for SMC Products” (M-E03-3) before using.

SMC Corporation

Akihabara UDX 15F,
4-14-1, Sotokanda, Chiyoda-ku, Tokyo 101-0021, JAPAN
Phone: 03-5207-8249 Fax: 03-5298-5362
<http://www.smcworld.com>
© 2012 SMC Corporation All Rights Reserved

Specifications are subject to change without prior notice and any obligation on the part of the manufacturer.

D-G

1st printing QW printing QW 8150SZ Printed in Japan.